

www.somfy.com



Sonesse[®] 40 RTS



Ref: 5064823A

HOME
MOTION BY

somfy[®]

EN

Installation instructions

SOMFY hereby declares that this product complies with the essential requirements and other relevant provisions of Directive 1999/5/EC. A Declaration of Conformity is available at the web address www.somfy.com/CE. Suitable for use in EU, CH and NO

CONTENT

1 Introduction

2 Safety

2.1 General information

2.2 General safety advice

3 Installation

4 Commissioning

4.1 Programming the RTS transmitter

4.2 Checking the rotation direction

4.3 Adjusting the end limits

4.4 Recording the RTS transmitter

4.5 Mode Selection: Roller or Tilting mode

4.6 Favorite position : MY position

Recording MY position.

5 Use

5.1 Up, Down, My: In roller mode

5.2 Up, Down, My: In tilting mode

6 Sun function

6.1 Introduction

6.2 Sun disappearing position

7 Modifying the settings

7.1 End limit re-adjustment

7.2 Favorite position : MY position

Changing the MY position / Delete the MY position

7.3 Modifying the motor rotation direction

7.4 Modifying the wheel rotation direction

7.5 Scroll wheel increment setting

7.6 Replacement of a lost remote control

7.7 Adding/Deleting RTS transmitter

7.8 Adding/Deleting RTS sensors

7.9 Erase the memory of the motor

8 Troubleshooting

9 Technical data

10 Environment

1 Introduction

Product Description

The Sonesse® 40 is a motor specially dedicated to interior applications.

The Sonesse® 40 motor range can motorize all interior applications: Roller shades, Venetian blinds, Roman shades, Pleated & cellular shades, Projection screens.

The Sonesse® 40 is designed to ensure quiet operations.

Warning: The Sonesse® 40 isn't compatible with wind functions.

2 Safety

2.1 General information

- This Somfy product must be installed by a professional motorisation and home automation installer, for whom these instructions are intended.
- Before installation, check that this product is compatible with the associated equipment and accessories.
- These instructions describe how to install, commission and use this product.
- Moreover, the installer must comply with current standards and legislation in the country in which the product is being installed, and inform his customers of the operating and maintenance conditions for the product.
- Any use outside the sphere of application specified by Somfy is not approved. Such use, or any failure to comply with the instructions given herein will invalidate the warranty, and Somfy refuses to accept liability.

2.2 Specific safety advice

The safety instructions that must be observed, besides the usual rules, are explained in these instructions and in the attached «Safety Instructions» document.

Never immerse the motor in liquid!



Avoid impacts!



Never drill holes in the motor!



Do not drop it!



3 Installation

Motor preparation

- 1) Fit the crown (a) and drive wheel (b) to the motor.
- 2) Measure the length (L) between the end of the drive wheel and the head end.

Tube preparation

- 1) Cut the tube to the required length.
 - 2) Deburr the tube and remove the debris.
- For smooth roller tubes, cut a notch with the following measurements: e = 6 mm h = 10 mm

Motor/tube assembly

- 1) Slide the motor into the tube.
- For smooth roller tubes, position the notch previously cut on the crown.
- 2) Fix the tube to the motor with self-tapping screws or steel pop rivets depending on the dimension (L - 5 mm).

Mounting the motorized tube on the brackets

If necessary, screw the bracket interface on the motor head.

- 1) Mount the motorized tube on the end bracket (c).
- 2) Mount the motorized tube on the motor bracket (d).

Wiring

- 1) Switch off the power supply.
- 2) Connect the motor according to the information in the table below.

RANGE	1 Neutral	2 Live	3 Earth
230V-50HZ	Blue	Brown	NA
120V-60HZ	White	Black	Green
220V-60HZ	Blue	Brown	NA

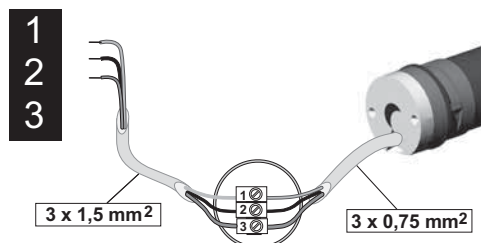
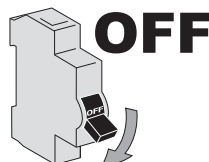
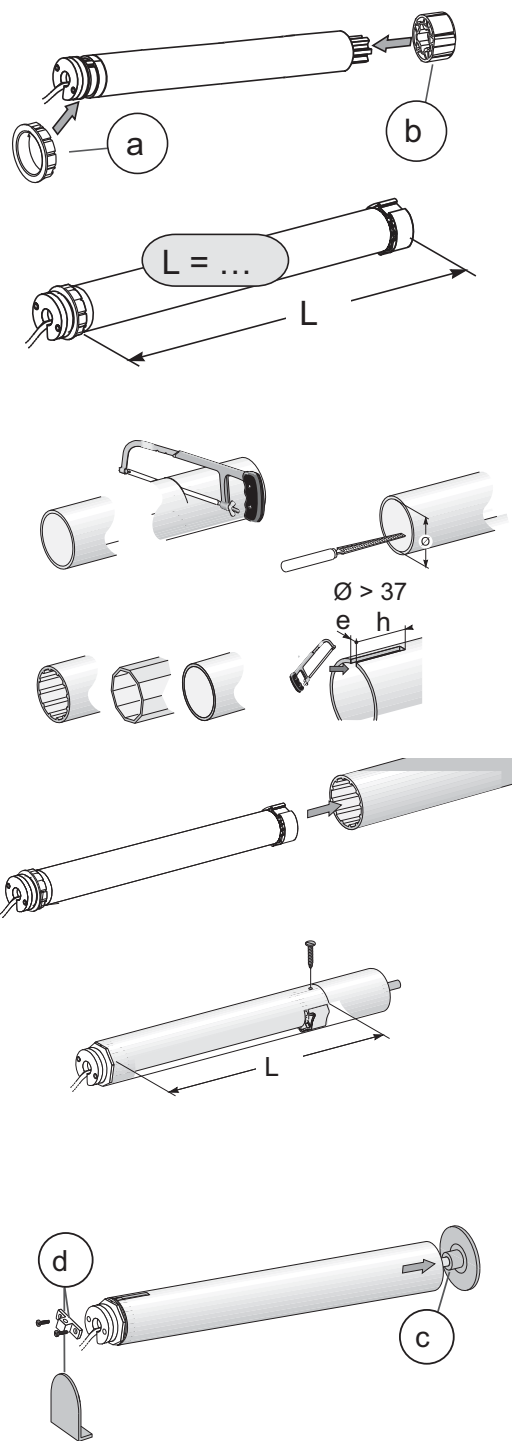

4 Commissioning

4.1 Programming the RTS transmitter

Switch on the power supply.

Press the UP and DOWN buttons simultaneously on the RTS transmitter: the jogs (move up and down briefly) and the transmitter is preprogrammed in the motor

4.2 Checking the rotation direction

- 1) Press the RTS transmitter UP button:
 - a) If the shade is raised (a), the rotation direction is correct: move to the section entitled «Adjusting the end limits».
 - b) If the shade is lowered (b), the rotation direction is incorrect: move to the next step.
- 2) Press the RTS transmitter MY button until the shade jogs: the rotation direction has been modified.
- 3) Press the RTS transmitter UP button to check the rotation direction.

4.3 Adjusting the end limits

The limits can be set in any sequence.

- 1) Press and hold the UP button to move the shade to the desired Up position. If necessary adjust the Up position, using the UP or DOWN buttons.
- 2) Press the MY and DOWN buttons simultaneously and release them once the shade begins to move. The Up limit is memorized.
- 3) Press the MY button when it reaches the desired Down position.
If necessary adjust the Down position, using the UP or DOWN buttons.
- 4) Press the MY and UP buttons simultaneously and release them when the shade begins to move.
The Down limit is memorized. The shade moves up and will stop at its upper limit.
- 5) To confirm the end limits press and hold the MY button until the shade jogs. The end limits are recorded.

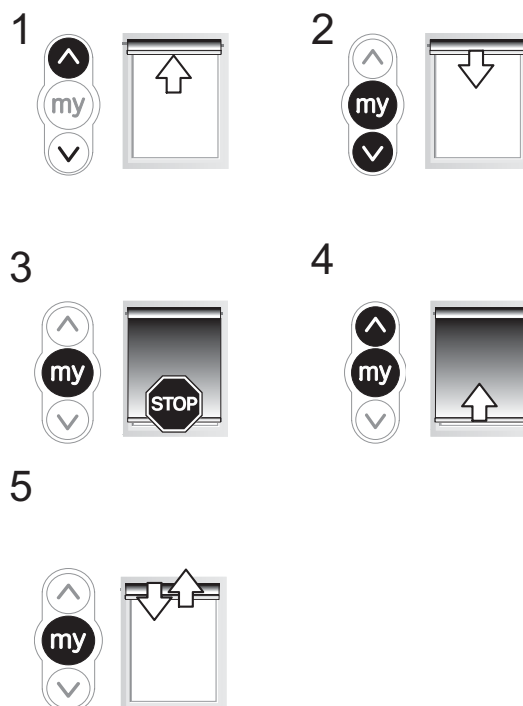
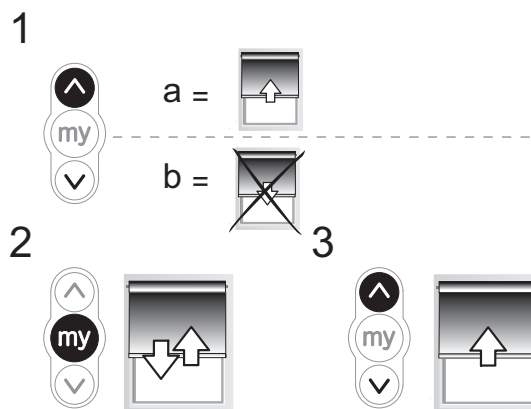
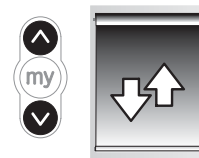
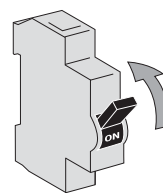

4.4 Recording the RTS transmitter

After recording the end limit:

Press briefly the programming button on the back of the transmitter. The shade jogs.

The transmitter is recorded.

OR

- 1) Switch off the current.
- 2) Switch on the current. The shade jogs.
- 3) Simultaneously press the UP and DOWN buttons on the RTS transmitter.

The shade jogs.

- 4) Press briefly the programming button on the back of the transmitter. The shade jogs.

The transmitter is recorded.

4.5 Mode selection: Roller or Tilting mode

The Sonesse® 40 RTS is designed to work with 2 modes: Venetian blind mode or roller blind mode.

The Sonesse® 40 RTS is set by default to work in roller blind mode.

This feature allows the Sonesse® 40 RTS to be set according to the type of blind you are working with.

Move the shade away from the end limits.

- 1) Simultaneously press the UP and DOWN buttons until the shade jogs.
- 2) Press and hold the MY and DOWN buttons simultaneously until the shade jogs to change from Roller mode to Tilting mode.

4.6 Favorite position: MY position Recording MY position.

To set the MY position, move the shade to the desired position with the UP and DOWN buttons then press the MY button until the shade jogs.

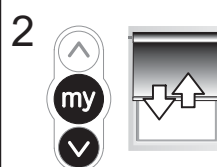
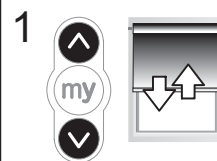
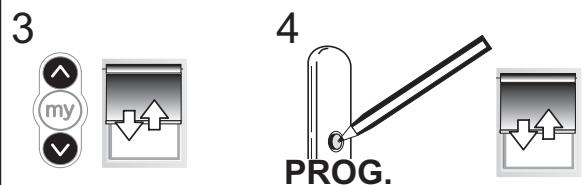
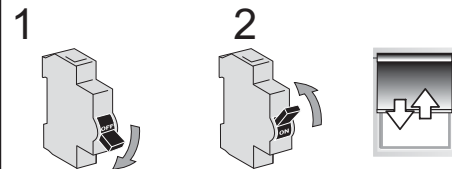
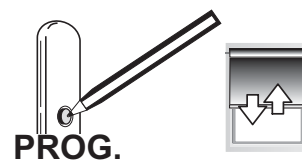

5 Use

5.1 Up, Down, My: In roller mode

- 1) To move the shade from a limit to the other limit, press briefly the UP or DOWN button.
- 2) To stop the shade, press the MY button.
- 3) To move the shade to the MY position, press briefly the MY button.

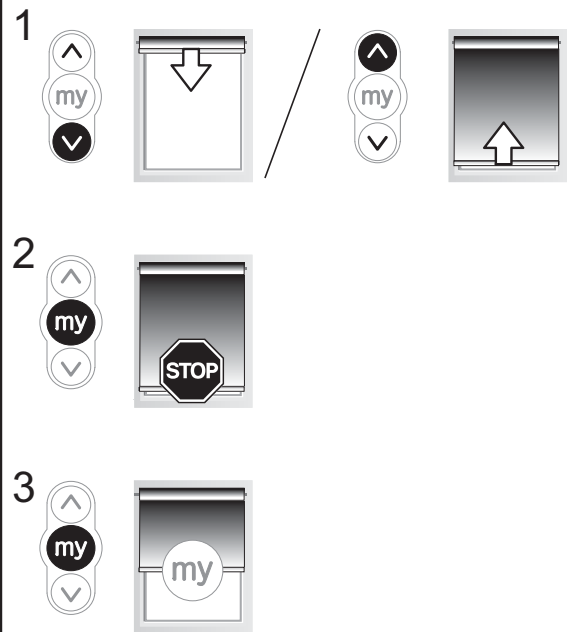

5.2 Up, Down, My: In tilting mode

- 1) To move the shade from a limit to the other limit, press briefly (less than 0,5s) the UP or DOWN button.
- 2) To stop the shade, press the MY button.
- 3) To move the shade to the MY position, press briefly the MY button.
- 4) To tilt the slats, press and hold the UP or DOWN button or use the scroll of the remote control until the slats reach the desired position.

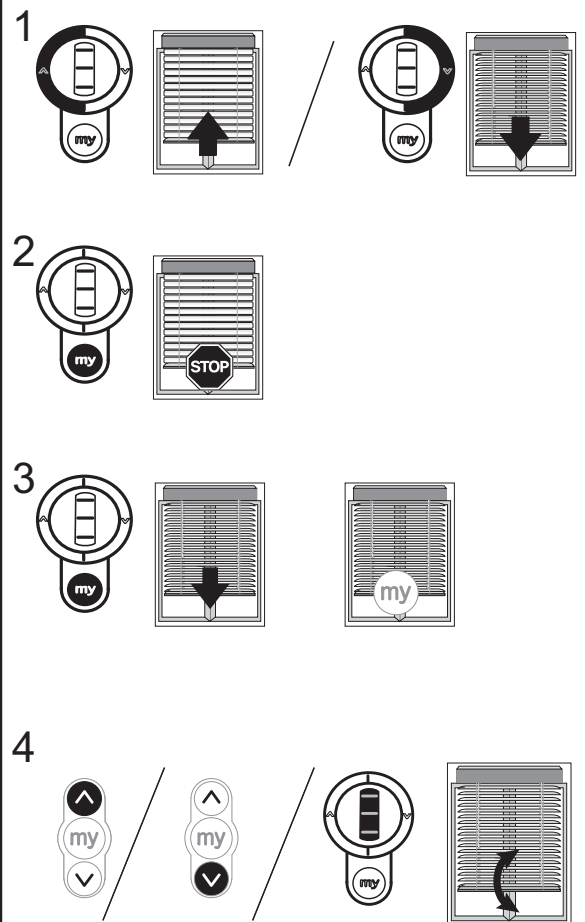

6 Sun function

6.1 Introduction

For this function, you need a Telis Soliris transmitter.

By default, the Sun function is not active.

1) To activate the Sun function, press the SELECT button on the Telis Soliris transmitter until the shade jogs.

2) To deactivate the Sun function, press the SELECT button on the Telis Soliris transmitter until the shade jogs.

When the intensity of the daylight exceeds the threshold set by the Soliris sensor RTS, an order is sent to the shade after 2 min.

The shade goes to the MY position or to its down limit if no MY position has been memorised.

When the intensity of the daylight falls below the threshold set by the Soliris sensor RTS, the shade goes to the sun disappearing position or stays at its position (MY or Down limit) if no sun disappearing position has been memorised.

To set the sun disappearing position, see 6.2 part.

The Wind function is not compatible with this motor.

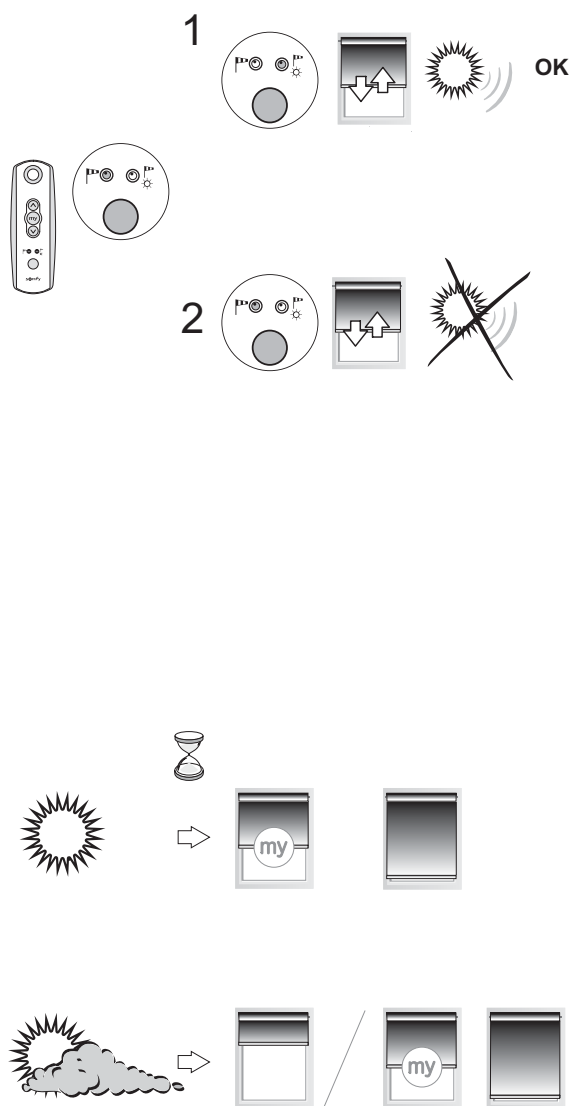

6.2 Sun disappearing position

This function is available only if a MY position is recorded.

1) Recording Sun disappearing position

Press and hold the MY and DOWN buttons until the shade moves.

In tilting mode : The shade will move to the lower limit and return to the MY position.

In roller mode: The shade will move to the MY position.

Move the shade to the desired position with the UP and DOWN buttons.

Press and hold the MY button until the shade jogs.
The Sun disappearing position is recorded.

2) Changing the Sun disappearing position

Press and hold the MY and DOWN buttons until the shade moves.

In tilting mode : The shade will move to the lower limit and return to the Sun disappearing position.

In roller mode: The shade will move to the Sun disappearing position.

Move the shade to the new desired position with the UP and DOWN buttons.

Press and hold the MY button until the shade jogs.
The Sun disappearing position is changed.

3) Delete the Sun disappearing position

Press and hold the MY and DOWN buttons until the shade moves.

In tilting mode : The shade will move to the lower limit and return to the Sun disappearing position.

In roller mode: The shade will move to the Sun disappearing position.

Press and hold the MY button until the shade jogs.
The Sun disappearing position is deleted.

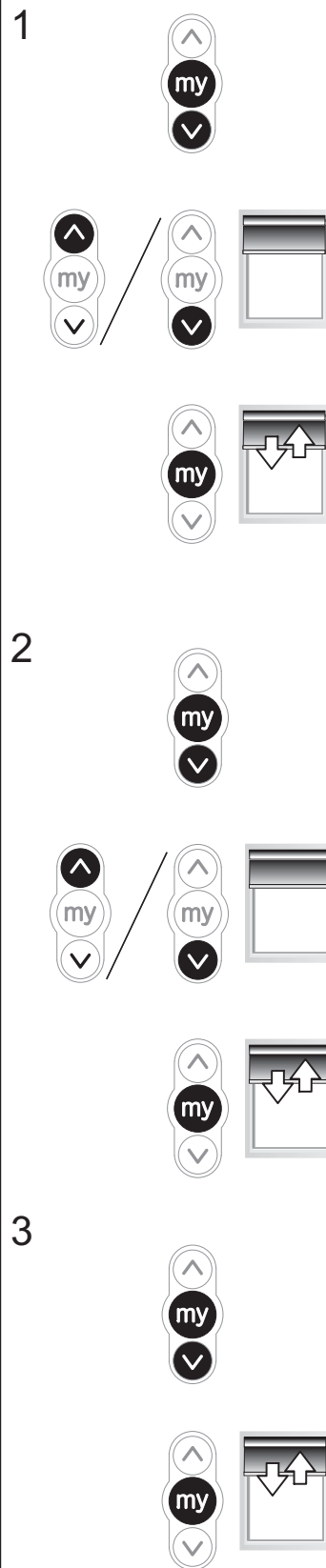

7 Modifying the settings

7.1 End limit re-adjustement

UP LIMIT

- 1) Press the UP button, to move the shade to the limit to be readjusted.
- 2) Press and hold the UP and DOWN buttons simultaneously until the shade jogs.
- 3) Press and hold the UP or DOWN button to move the shade to the new desired position.
- 4) To confirm the new limit press and hold the MY button until the shade jogs.

DOWN LIMIT

- 1) Press the DOWN button to move the shade to the limit to be readjusted.
- 2) Press and hold the UP and DOWN buttons simultaneously until the shade jogs.
- 3) Press and hold the UP or DOWN button to move the shade to the new desired position.
- 4) To confirm the new limit press and hold the MY button until the shade jogs.

7.2 Favorite position : MY position

1) Changing the MY position

To change the MY position go to the new desired MY position with the UP and DOWN buttons then press the MY button until the shade jogs.

2) Deleting the MY position

Press the MY button to move to this position
To delete the MY position, move to this position and press the MY button until the shade jogs.

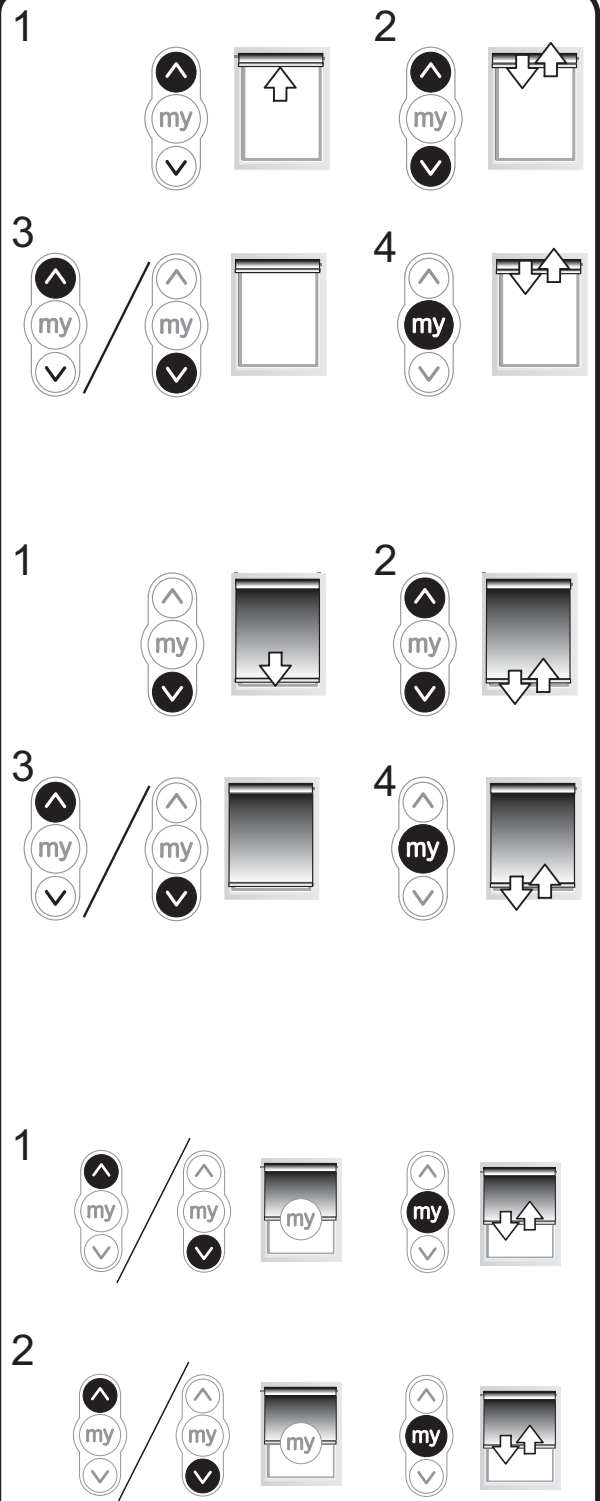

7.3 Modifying the motor rotation direction

Move the shade away from the end limits.

- 1) Press the UP and DOWN buttons simultaneously until the shade jogs.
- 2) Press the MY button until the shade jogs to reverse the rotation direction.
- 3) Press the UP button to check the new rotation direction.

The motor rotation direction is reversed.

7.4 Modifying the wheel rotation direction

Move the shade away from the end limits.

- 1) Press the UP and DOWN buttons simultaneously until the shade jogs.
- 2) Press the UP, MY and DOWN buttons simultaneously until the shade jogs to reverse the wheel rotation direction.

The wheel rotation direction is reversed.

7.5 Scroll wheel increment setting

- 1) Press the UP, MY and DOWN buttons simultaneously until the shade jogs twice.
- 2) Use the Up and Down buttons to readjust the scroll wheel movement.
The result can be test in live with the scroll wheel.
- 3) To confirm the new setting, press the MY button until the shade jogs.

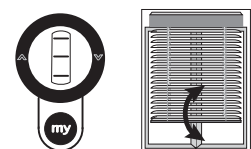
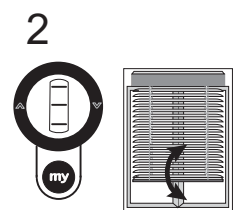
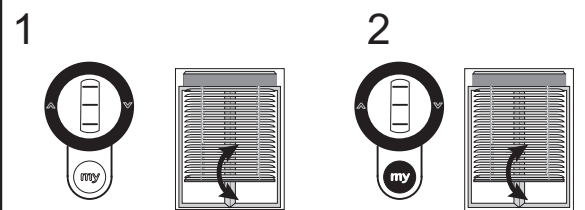
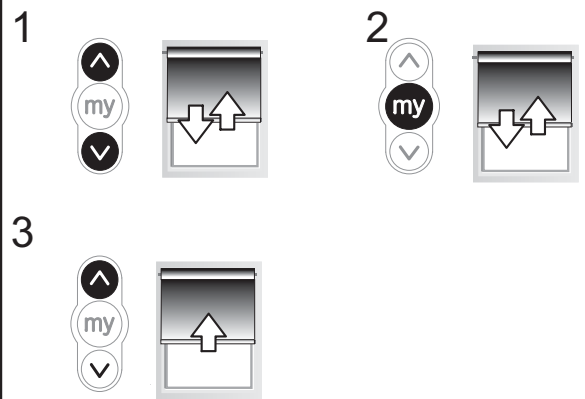

X 2

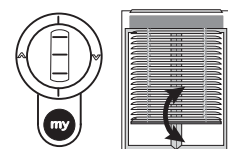
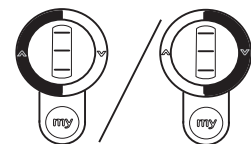

7.6 Replacement of a lost remote control

N.B.: This reset deletes all transmitters programmed, but end-limits, intermediate position and sensors are retained.

N.B.: Only switch off the current for the motor where a transmitter is lost.

- 1) Cut the power supply for 2 seconds.
- 2) Switch the power supply back on for 10 to 15 seconds.
- 3) Cut the power supply for 2 seconds.
- 4) Switch the power supply back on: the shade moves during 5 seconds (If the shade position is an end limit, the behavior of the shade will be a jog).
- 5) Press the RTS transmitter (B) PROG button until the shade jogs: all the RTS transmitters are cleared and the new RTS transmitter is programmed in the motor.

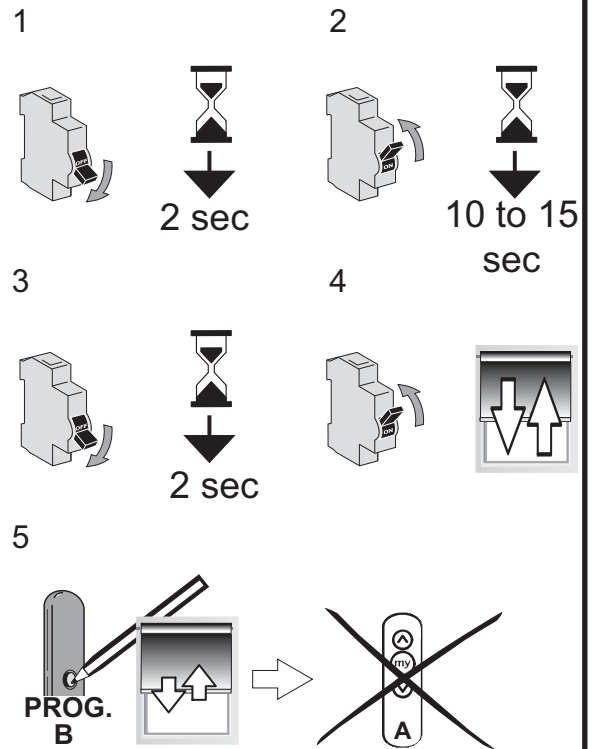

7.7 Adding/Deleting RTS transmitter

Find an RTS transmitter programmed in the motor. Press and hold the RTS programmed transmitter (A) PROG button until the shade jogs: the motor is in programming mode. Press briefly the RTS transmitter (B) PROG button to add or delete this transmitter: the shade jogs and the RTS transmitter is programmed or deleted from the motor.

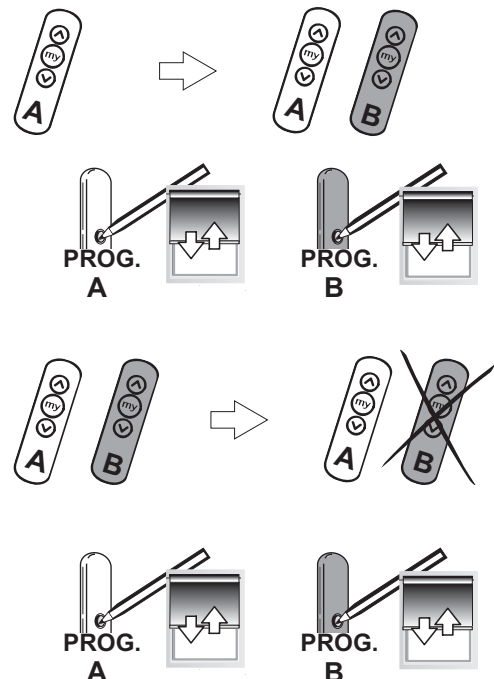

7.8 Adding/Deleting RTS sensors

Find an RTS transmitter programmed in the motor. Press and hold the RTS programmed transmitter (A) PROG button until the shade jogs: the motor is in programming mode.

Press briefly the RTS sensor (C) PROG button to add or delete this sensor: the shade jogs and the RTS sensor is programmed or deleted from the motor.

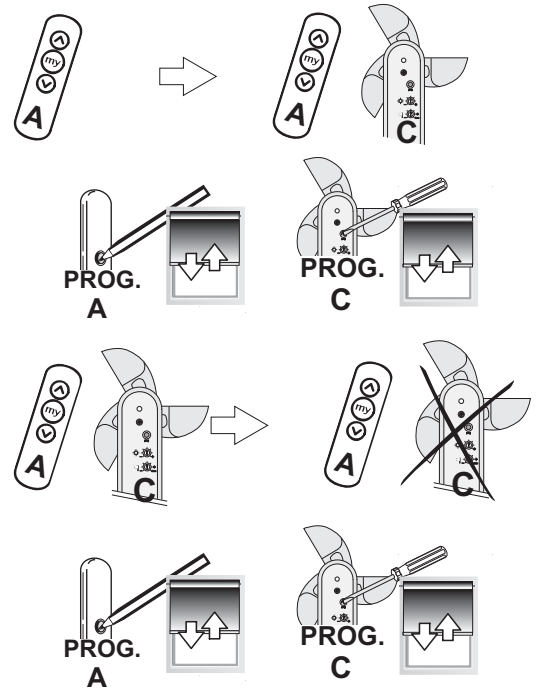

7.9 Erase the memory of the motor.

N.B.: This reset deletes all RTS transmitters, RTS sensors, end-limits and intermediate position programmed.

N.B.: Only switch off the current for the motor to be reset!

N.B.: Before cutting the power, move the shade to the middle position.

- 1) Cut the power supply for 2 seconds.
- 2) Switch the power supply back on for 10 to 15 seconds.
- 3) Cut the power supply for 2 seconds.
- 4) Switch the power supply back on: the shade moves during 5 seconds (If the shade position is an end limit, the behavior of the shade will be a jog).
- 5) Press the RTS transmitter (A) PROG button until the shade jogs twice: all the RTS transmitters, RTS sensors, end-limits and intermediate position are cleared.

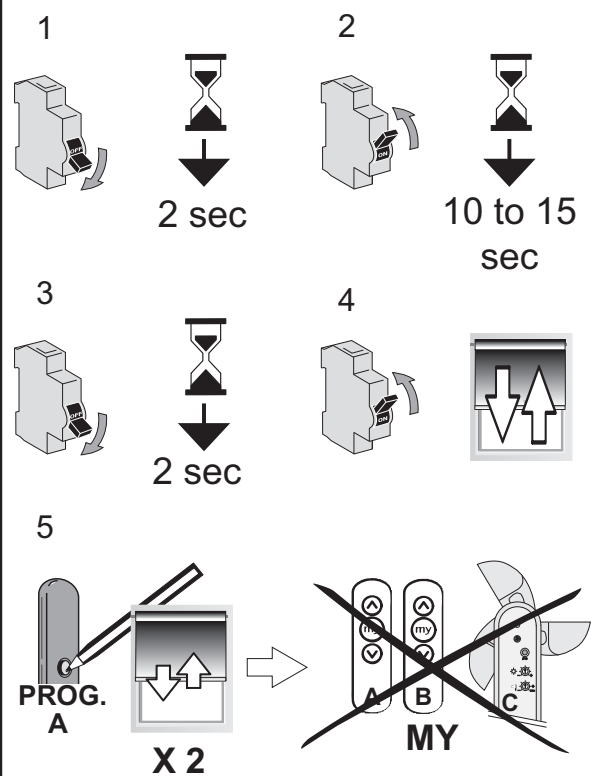

8 Troubleshooting

The motor doesn't work:

Verify:

- The wiring of the motor.
- The power supply specifications.
- The compatibility of the control
- The heat generated (wait for the cooling of the motor).

The equipment stops too soon:

Verify:

- The operation of end-limits during the rotation of the motor.
- The crown is properly fitted to the tube.
- The end-limits of the motor are properly adjusted.
- That the shade is within the recommended weight limit.

The equipment is noisy:

Verify that:

- The wheel and the crown are well adapted to the used tube.
- The mechanical plays between motor, accessories, tube and end of tube must be decreased to the maximum.
- The wheel is properly fixed to the tube.
- The equipment is not constrained between the brackets.
- The length of the notch is adapted to the motor hook or to the used crown.
- Debris, screws or other are not in your tube.
- The power supply specifications.
- The temperature of the environment is in conformity with the operating temperature.

9 Technical data

Power supply	230V/50Hz - 120V/60Hz - 220V/60Hz
Frequency	433,42MHz
Operating temperature	0°C / 60 °C
Protection rating	IP44
Maximum number of transmitters	12
Maximum number of sensors	3

10 Environment



Damaged electric products and batteries should not be disposed of with normal household waste.

Make sure to drop them in specially provided containers or at an authorized organization that will ensure they are recycled

Somfy worldwide

Argentina: Somfy Argentina
Tel: +55 11 (0) 4737-3700

Australia: Somfy PTY LTD
Tel: +61 (2) 8845 7200

Austria: Somfy GesmbH
Tel: +43 (0) 662 / 62 53 08 - 0

Belgium: Somfy Belux
Tel: +32 (0) 2 712 07 70

Brasil: Somfy Brasil Ltda
Tel: +55 11 3695 3585

Canada: Somfy ULC
Tel: +1 (0) 905 564 6446

China: Somfy China Co. Ltd
Tel: +8621 (0) 6280 9660

Croatia : Somfy Predstavništvo
Tel: +385 (0) 51 502 640

Cyprus : Somfy Middle East
Tel: +357(0) 25 34 55 40

Czech Republic:
Somfy, spol. s.r.o.
Tel: (+420) 296 372 486-7

Denmark: Somfy Nordic
Danmark
Tel: +45 65 32 57 93

Export: Somfy Export
Tel: + 33 (0)4 50 96 70 76
Tel: + 33 (0)4 50 96 75 53

Finland: Somfy Nordic AB
Finland
Tel: +358 (0)9 57 130 230

France : Somfy France
Pour les professionnels :
Tel. : +33 (0) 820 374 374
Pour les particuliers :
Tel. : +33 (0) 810 055 055

Germany: Somfy GmbH
Tel: +49 (0) 7472 930 0

Greece: Somfy Hellas S.A.
Tel: +30 210 6146768

Hong Kong: Somfy Co. Ltd
Tel: +852 (0) 2523 6339

Hungary : Somfy Kft
Tel: +36 1814 5120

India: Somfy India PVT Ltd
Tel : +(91) 11 4165 9176

Indonesia: Somfy Jakarta
Tel: +(62) 21 719 3620

Iran: Somfy Iran
Tel: +98-217-7951036

Israel: Sisa Home Automa-
tion Ltd
Tel: +972 (0) 3 952 55 54

Italy: Somfy Italia s.r.l
Tel: +39-024847181

Japan: Somfy KK
Tel: +81 (0)45 481 6800

Jordan: Somfy Jordan
Tel: +962-6-5821615

Kingdom of Saudi Arabia:
Somfy Saoudi
Riyadh :
Tel: +966 1 47 23 020
Tel: +966 1 47 23 203
Jeddah :
Tel: +966 2 69 83 353

Kuwait: Somfy Kuwait
Tel: +965 4348906

Lebanon: Somfy Lebanon
Tel: +961 (0) 1 391 224

Malaisia: Somfy Malaisia
Tel:+60 (0) 3 228 74743

Mexico: Somfy Mexico SA
de CV
Tel: 52 (55) 4777 7770

Morocco: Somfy Maroc
Tel: +212-22443500

Netherlands: Somfy BV
Tel: +31 (0) 23 55 44 900

Norway: Somfy Nordic Norge
Tel: +47 41 57 66 39

Poland: Somfy SP Z.O.O.
Tel: +48 (22) 50 95 300

Portugal: Somfy Portugal
Tel. +351 229 396 840

Romania: Somfy SRL
Tel.: +40 - (0)368 - 444 081

Russia: Somfy LLC.
Tel: +7 495 781 47 72

Serbia: SOMFY Predstavništvo
Tel: 00381 (0) 25 841 510

Singapore: Somfy PTE Ltd
Tel: +65 (0)6383 3855

Slovak republic: Somfy, spol.
s r.o.
Tel: +421 337 718 638
Tel: +421 905 455 259

South Korea: Somfy JOO
Tel: +82 (0) 2594 4331

Spain: Somfy Espana SA
Tel: +34 (0) 934 800 900

Sweden: Somfy Nordic AB
Tel: +46 (0)40 16 59 00

Switzerland: Somfy A.G.
Tel: +41 (0) 44 838 40 30

Syria: Somfy Syria
Tel: +963-9-55580700

Taiwan: Somfy Development
and Taiwan Branch
Tel: +886 (0) 2 8509 8934

Thailand: Bangkok Regional
office
Tel: +66 (0) 2714 3170

Tunisia: Somfy Tunisia
Tel: +216-98303603

Turkey: Somfy TurkeyMah.
Tel: +90 (0) 216 651 30 15

United Arab Emirates:
Somfy Gulf Jebel Ali Free Zone
Tel: +971 (0) 4 88 32 808

United Kingdom: Somfy
Limited.
Tel: +44 (0) 113 391 3030

United States: Somfy Systems
Tel: +1 (0) 609 395 1300

